

Envirotainer[®]

The Active Cold Chain

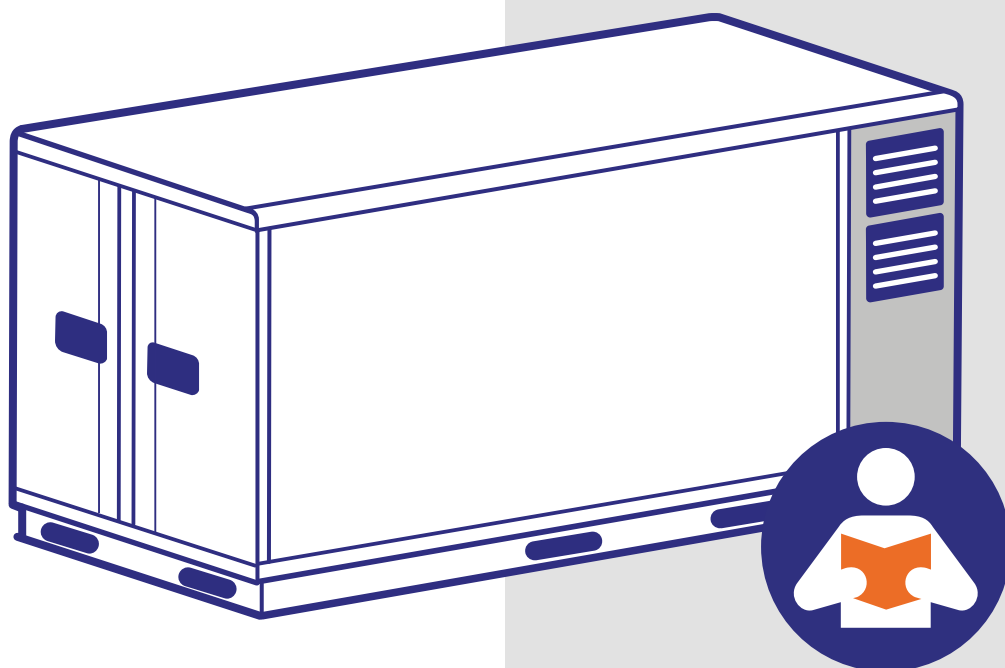

Releye[®] RLP User Manual

**RLP container,
Model 160020R, P/N 160020R-A-()-(),
P/N 160020R-1**

Doc No. UM-RLP-1000
Version 9

www.envirotainer.com

Doc No:

UM-RLP-1000

Revision:

9

State

Released

Release date:

2023-06-26

Approved by

hanst

RECORD OF REVISION

VER. NO.	REVISION
9	<p>REVISED:</p> <ul style="list-style-type: none"> • 1.2.1 Operating environment: Clarified the maximum relative humidity. Removed the standard text for the container enclosure ingress protection. • 1.5 Declaration of conformity: Declaration of Conformity updated. • 2.1.2 Symbols on the container: Updated sticker positions and added Releye stickers (also info about stickers on roof, pos C) according to drawing. • 3.2 Overview: Revised illustration. • 3.3 Refrigeration system operation: Revised air flow illustration. • 4.4.2.2.1 Pre-condition using the internal pre-conditioning program: Revised illustration. • 4.4.2.2.2 Pre-condition using a temperature controlled room: Revised illustration. • 4.4.4 Charging the container: Added warning about charging outdoors or in damp and/or humid environments. • 4.4.3 Loading the cargo: Revised illustrations. • 4.4.7 Operating the display unit: Added container status to illustration and table. • 4.4.7.4 Check the battery level: Added container status in illustration. • 4.4.7.5 View and address active alarms and alerts: Added container status in illustration. • 4.4.7.8 Lock and unlock the display unit for input: Added container status in illustration. • 6. Technical specification: <ul style="list-style-type: none"> • Removed IP rating. • Added free temperature set point. Changed set point accuracy to +/-2 degrees for any set point.

TABLE OF CONTENTS

1. INTRODUCTION	1
1.1 Container type	1
1.2 Intended use	1
1.2.1 Operating environment	1
1.3 Manufacturer	2
1.4 Contact	2
1.5 Declaration of conformity	3
2. SAFETY	4
2.1 Symbols	4
2.1.1 Symbols in the manual	4
2.1.2 Symbols on the container	5
2.1.2.1 ODLN sticker	6
3. CONTAINER DESCRIPTION	7
3.1 Orientation conventions	7
3.2 Overview	8
3.3 Refrigeration system operation	9
3.4 Walls	10
3.5 Operating conditions	10
4. USING THE CONTAINER	11
4.1 Preparing a shipment	11
4.2 Shipping	12
4.3 Finishing a shipment	12
4.4 Operating instructions	13
4.4.1 Lifting and moving the container	13
4.4.1.1 Lift from the sides	13

→

4.4.1.2	Lift from the front (door side)	14
4.4.1.3	Lift from the rear (machine room side).....	14
4.4.1.4	Lift with an electric pallet jack	14
4.4.1.5	Use a roller bed system	15
4.4.2	Pre-conditioning the cargo and the container	15
4.4.2.1	Pre-condition the cargo	15
4.4.2.2	Pre-condition the container	15
4.4.3	Loading the cargo	19
4.4.4	Charging the container	22
4.4.4.1	Safety precautions	22
4.4.4.2	The charging unit	23
4.4.4.3	Charge the container	23
4.4.4.4	Order additional charging adapters	25
4.4.5	Precautions during a shipment	26
4.4.6	Storing the container	26
4.4.7	Operating the display unit	27
4.4.7.1	The display unit.....	27
4.4.7.2	Wake the display up from sleep mode	29
4.4.7.3	Set the temperature	29
4.4.7.4	Check the battery level	30
4.4.7.5	View and address active alarms and alerts	31
4.4.7.6	Turn the temperature control off.....	32
4.4.7.7	Disable connectivity.....	32
4.4.7.8	Lock and unlock the display unit for input	34
5.	TROUBLESHOOTING.....	35
5.1	Information messages	35
5.2	Alerts.....	35

→

5.3 Alarms..... 36

5.4 Hardware..... 37

6. TECHNICAL SPECIFICATION..... 39

6.1 Definition of dimensions 40

Intentionally left blank

1. INTRODUCTION

This manual is intended for shipper, forwarder and airline personnel involved in the operation of the Envirotainer Releye® RLP container. The manual is published by Envirotainer AB without warranty.

1.1 CONTAINER TYPE

The container is an active Unit Load Device (ULD) according to ETSO-C90d A1, including non-ETSO functions, primary to keep cargo in a temperature-controlled environment.

The container is a 2L5C designed according to AS36100 and LD-11.

1.2 INTENDED USE

The container is designed for transporting temperature sensitive cargo, and is intended for use in aircraft, trucks and trains. The container may also be transported by ship when empty or loaded with non temperature sensitive cargo.

Operating conditions when transporting temperature sensitive cargo are stated in **3.5 Operating conditions**.

The container may only be handled and operated in accordance with the instructions given in this manual.

Operational limitations regarding maximum gross weight, ambient temperatures and power requirements stated in the **6. Technical specification** must not be exceeded.

When loaded on an aircraft, or other means of transportation, the container must run on battery power. It must never be connected to a power outlet inside an aircraft or other means of transportation.

Connectivity:

The container is provided with connectivity equipment for wireless data transmission. This equipment has built in flight detection in accordance with AC 91.21-1D, sections 10.2 and 10.3. It uses two independent means to control the RF transmitters and automatically turns off the RF transmitters when the container is airborne.

A manual connectivity switch is also available, to override the automatic flight detection and enable transport on an aircraft for which the operator has not approved the use of equipment based on automatic flight detection in accordance with AC 91.21-1D, sections 10.2 and 10.3. Refer to **4.4.7.7 Disable connectivity**.

If there are questions about the intended use, refer to **1.4 Contact** for contact details.

1.2.1 OPERATING ENVIRONMENT

The container is designed to meet the following environmental conditions:

Maximum altitude (unpressurized)	AC power: 3000 m (9842 ft)
	Battery power: 4600 m (15 092 ft)
Minimum air pressure	0,506625 bar, corresponding to 15 000 ft at -5°C (23°F) or equivalent
Maximum relative humidity	MIL-STD-810; B3
Maximum supply voltage fluctuations	Up to ±10 % of the nominal voltage
Overvoltage category	Category II
Wet location	Wet location (outdoor use)
Applicable pollution degree	Pollution degree 3

→

Container enclosure ingress protection code	IP15B
Federal Communications Commission (FCC) information	This equipment has been tested and found to comply with the limits for a Class A digital device, pursuant to part 15 of the FCC Rules. These limits are designed to provide reasonable protection against harmful interference when the equipment is operated in a commercial environment. This equipment generates, uses and can radiate radio frequency energy and, if not installed and used in accordance with the instruction manual, may cause harmful interference to radio communications. Operation of this equipment in a residential area is likely to cause harmful interference in which case the user will be required to correct the interference at his own expense.

1.3 MANUFACTURER

The container is manufactured and provided by:

Envirotainer Engineering AB

Staffans väg 2A

SE-192 78 Sollentuna

SWEDEN

1.4 CONTACT

For contact information to our operations centers, refer to www.envirotainer.com.

For questions regarding the container or for reporting misleading, incorrect or insufficient data in the manual, send an e-mail to support@envirotainer.com.

For ordering of additional adapters, send an e-mail to logisticspareparts@envirotainer.com. Refer to

4.4.4.4 Order additional charging adapters for ordering details.

1.5 DECLARATION OF CONFORMITY

Envirotainer^o **DECLARATION OF CONFORMITY** according to EN ISO/IEC 17050-1:2010 **CE**

Manufacturer's Name: Envirotainer Engineering AB
Manufacturer's Address: Staffans väg 2A, SE-192 78 Sollentuna, Sweden
Manufacturing Site: Tallbacksgatan 12, SE-195 72 Rosersberg, Sweden

Declares under sole responsibility that the product as originally delivered

Product Name: Releye[®] RLP
Model Number: 160020R
Part Number: 160020R-A-()-()

complies with the essential requirements of the following applicable European Directive(s), and carries the CE marking accordingly:

Radio Equipment Directive 2014/53/EU (RED)

through the technical standards/specifications specified below:

Safety

IEC 61010-1- 2010-A1 2016	(in part excl battery)
EN 61010-1 2010+A1 2019	(in part excl battery)
RTCA/DO293a	(in part battery)
IEC 62133-1 2017	(battery cells)
IEC 61010-2-012 2019	
EN 61010-2-012 2016	
IEC 60529 2013	(IP15B)

EMC/Radio

EN 61000-6-1: 2019	
EN 61000-6-8:2020	
ETSI EG 203 366 V.1.1.1	RED guideline for combined radio products

Additional information:
 This product is an Air Cargo Unit Load Device (ULD) container 2L5C with temperature control system (heating and cooling) and connectivity system (Cargo Tracking Device).
 This product contains a separately CE-marked and FCC/IC listed transmitting device and carries that FCC and IC identifications numbers on the manufacturer's label.

Local contact for regulatory topics only:
 EU: Envirotainer Engineering AB, Staffans väg 2A, SE-192 78 Sollentuna, Sweden
 U.S.: Envirotainer Inc. 222 West Las Colinas Blvd Suite 1605 North Tower Irving TX 75039 USA
www.envirotainer.com

Rosersberg Sweden, June 14, 2023
 (Place and date of issue) _____  (Bernt Anderberg, CTO)

Document number: RE-00060	Revision: 1	Status: Released
Author: Patrik Gummesson	Date: 2023-06-14	Approver: bernta

Page 1 of 1

G00005558

Fig. 1 Declaration of conformity

2. SAFETY

- Read the manual before handling and operating the container.
- Pay attention to warning stickers and texts attached to the container.
- Before closing the doors, make sure that nobody is inside the cargo space.
- Observe normal precautions when handling locks, doors and lids.
- Always follow the "IATA Dangerous Goods Regulations" when loading the container.

2.1 SYMBOLS

2.1.1 SYMBOLS IN THE MANUAL

The following symbols are used in the manual:

 **WARNING!**

Indicates a possible danger that **can** lead to death or serious injury if necessary measures are not taken.

 **CAUTION!**

Indicates a possible hazard that **can** lead to injury or material / equipment damage if necessary measures are not taken.

 **NOTE!**

Practical information or tips on how to perform a procedure.

2.1.2 SYMBOLS ON THE CONTAINER

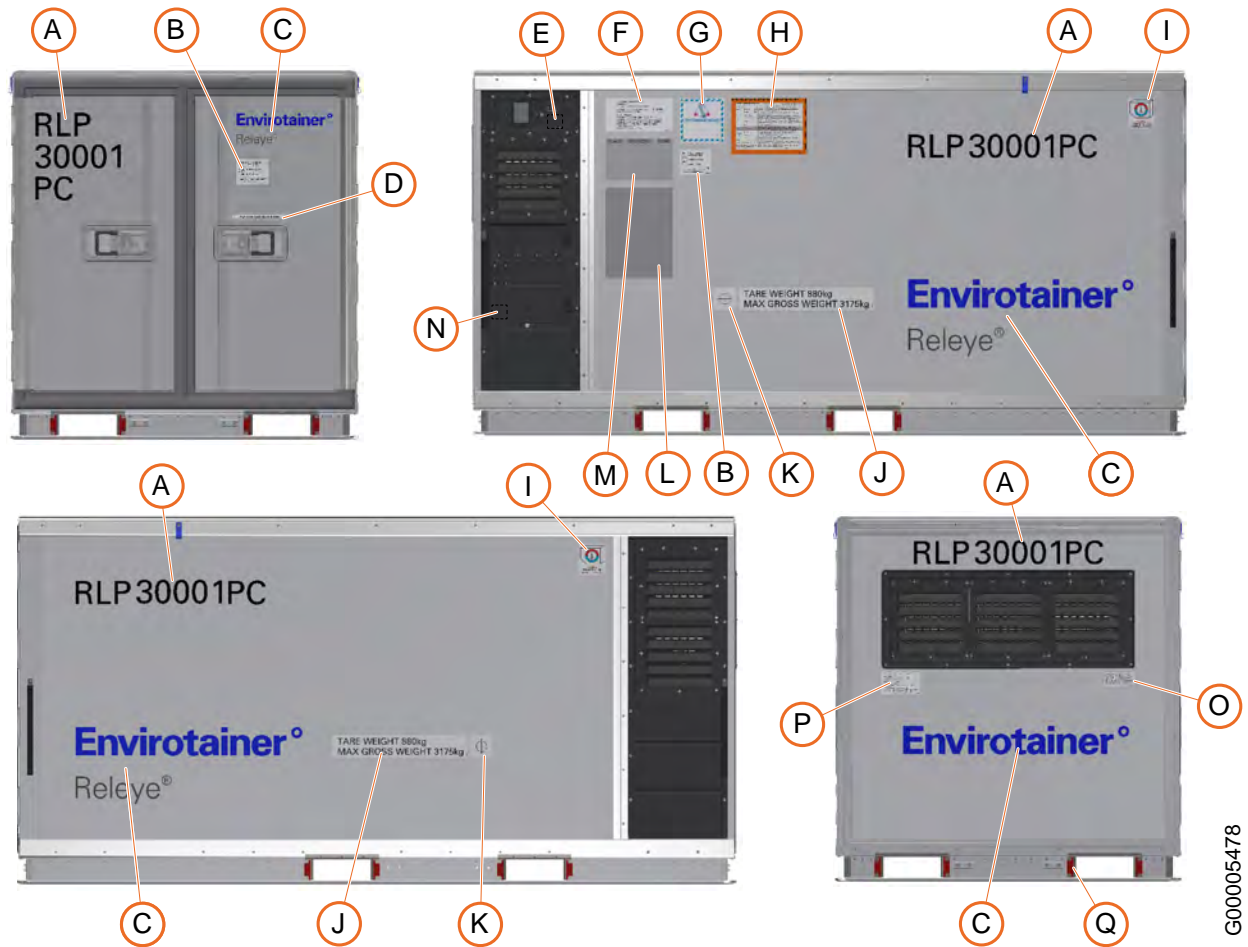

G00005478

Fig. 2 Symbols on the container

Table 1 Stickers

Pos	Name
A	IATA-code
B	Sticker "Contact information"
C	Stickers "Envirotainer" or "Envirotainer" and "Releye®" (also on roof)
D	Sticker "Seal"
E	Sticker "Auto - disabled"
F	Manufacturer's plate
G	Sticker "Time and temperature sensitive"
H	ODLN sticker
I	Sticker "Active ULD"

Pos	Name
J	Sticker "Tare weight"
K	Sticker "Center of gravity"
L	Document pouch
M	Sticker "Place stickers here"
N	Sticker "Do not charge inside aircraft"
O	Sticker "FAA"
P	Sticker "Non-TSO function"
Q	Sticker "Fork guides"

2.1.2.1 ODLN STICKER

The container is labeled with an Operational Damage Limits Notice (ODLN) sticker, in accordance with the IATA labelling requirements for aircraft containers. The ODLN describes the acceptable damage limits from an airworthiness perspective for safe carriage on the aircraft.

Before every lease, the container is inspected against even stricter criteria than those stated on the ODLN. Therefore, the container will never exhibit the level of damages as described on the ODLN when released from an Envirotainer station.

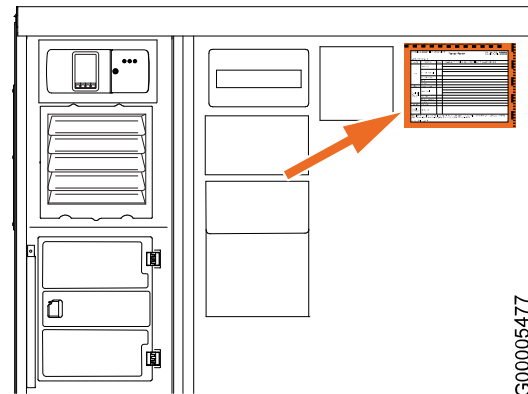

G00005477

Fig. 3 The ODLN sticker

3. CONTAINER DESCRIPTION

For information about container dimensions, loading capacity, temperature capacity, power consumption and battery autonomy, refer to **6. Technical specification**.

3.1 ORIENTATION CONVENTIONS

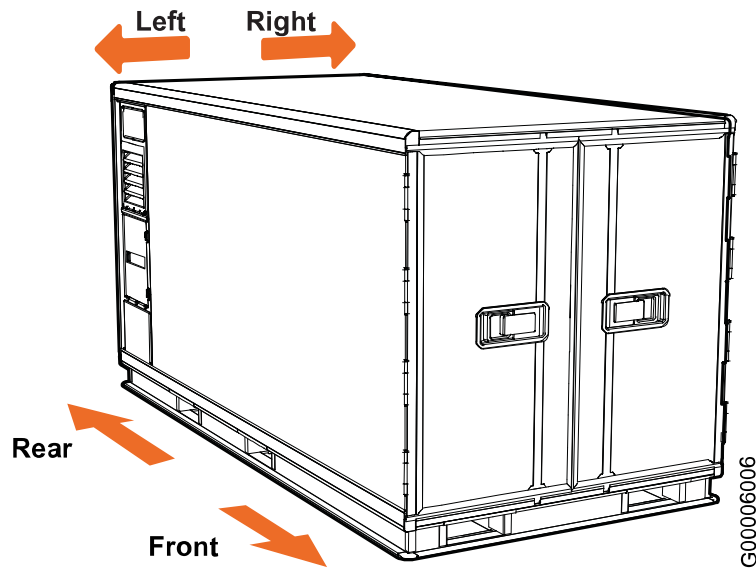
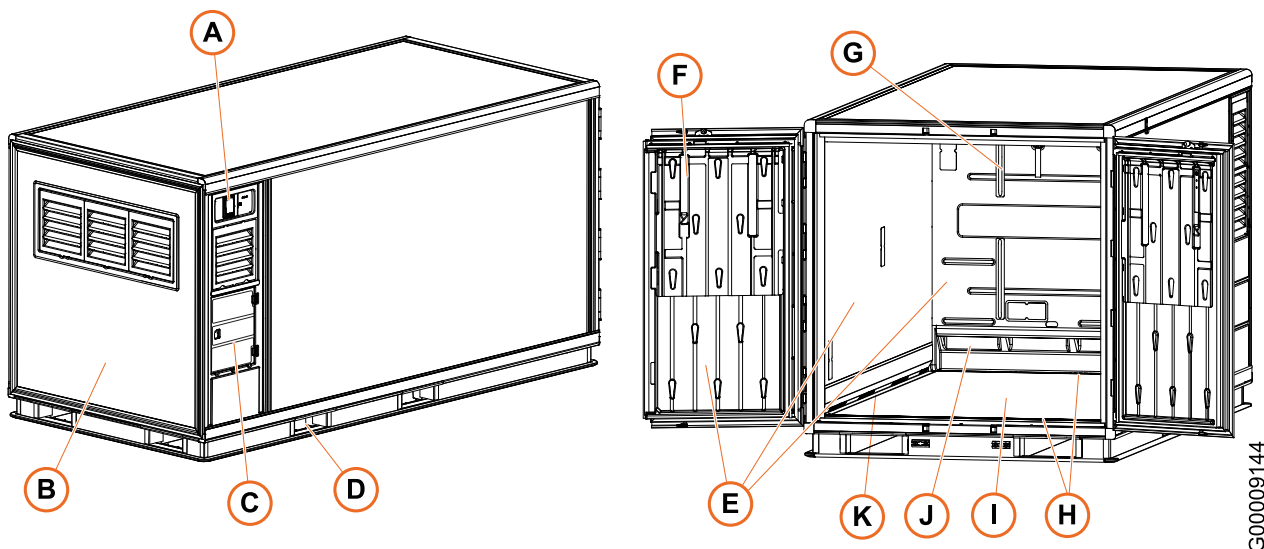

Fig. 4 Schematic view of the container with orientation conventions

3.2 OVERVIEW



G00009144

Fig. 5 Overview of the container

Table 2 Container features

Pos	Name	Description
A	Display unit	Used for: <ul style="list-style-type: none"> • Setting the cargo temperature set point • Starting pre-conditioning • Checking the battery level • Viewing activated alarms • Turning the refrigeration system on/off • Manually disabling the connectivity
B	Refrigeration system	In the machine room behind the service hatch. Includes rechargeable battery modules and mechanical refrigeration modules.
C	Charging unit	Contains charging cable and adapters.
D	Fork lift pocket	For lifting the container.
E	Air distribution panel	Contains several air channels for cooled or heated air.
F	Strap with hook	For locking the door in opened position.
G	Spacer	For securing a distance to the cargo.
H	Tie-down tracks	For securing cargo.
I	Cargo space	Contains air distribution panels, temperature sensors and tie-down tracks.
J	Return air outlet	For return air from the cargo space.
K	Air inlets	Supply the cooled or heated air from the air distribution panels into the cargo space.

3.3 REFRIGERATION SYSTEM OPERATION

The refrigeration system is powered by internal, rechargeable battery modules, and controlled by a control module. Sensors in the cargo space walls send signals to the control module, which controls a number of mechanical refrigeration modules, so that the correct temperature in the cargo space is maintained.

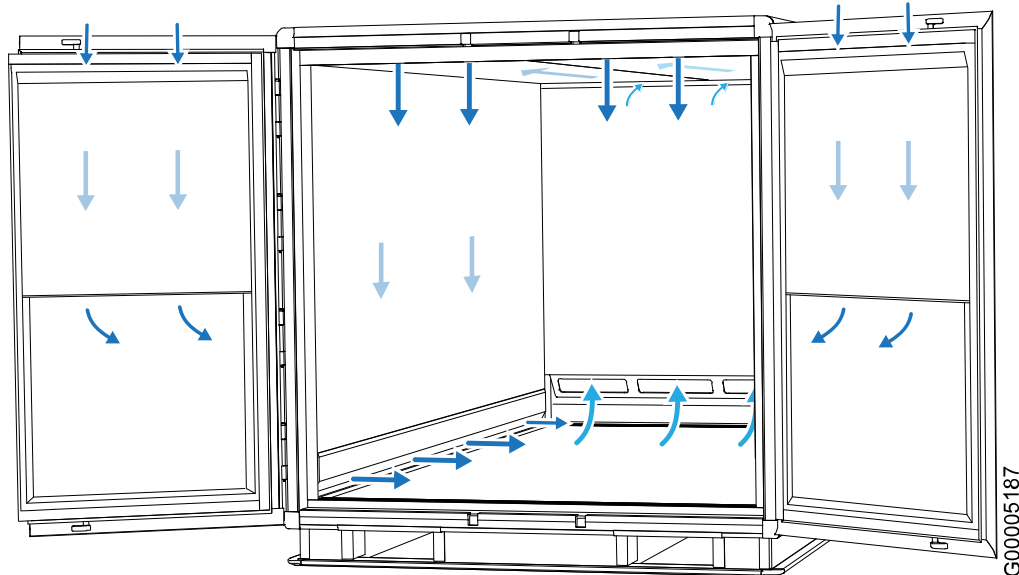

Fig. 6 Schematic view of the internal airflow

Temperature-controlled air is circulated from the mechanical refrigeration modules through the air distribution panels in the ceiling, walls and doors, and into the cargo space. The air travels along the inner floor and re-enters the refrigeration system through return air outlets in the partition wall at the rear of the cargo space.

To ensure proper air distribution in the cargo space, it is important that the cargo is placed on pallets. Ideally, cargo should be secured with straps to the tie down tracks in the inner floor.

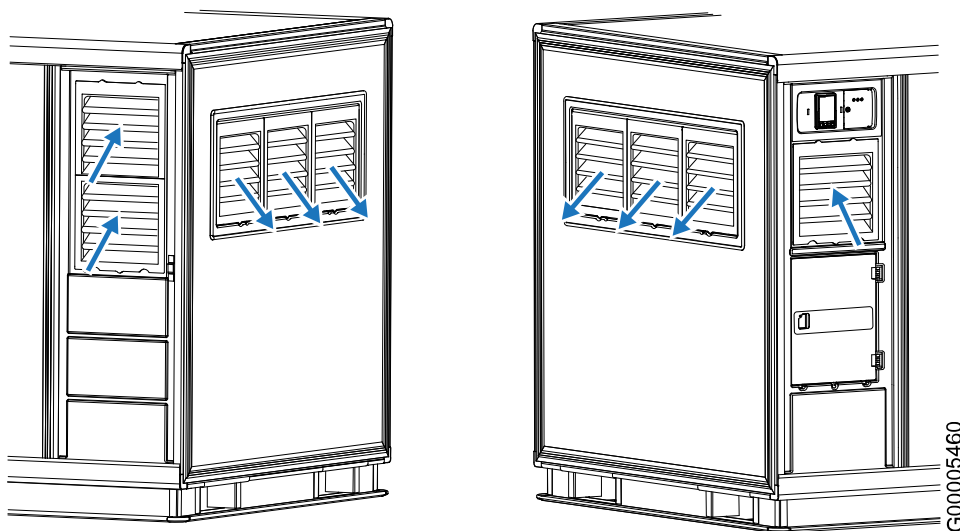

Fig. 7 Schematic view of the internal-external airflow transition

The air inlets on the container sides are used for cooling the modules in the machine room. The return air from the machine room is discharged through exhaust outlets in the service hatch.



The container is fitted with independent subsystems for both redundancy and reliability purposes:

- multiple mechanical refrigeration modules, each containing heater, cooler and fans
- multiple battery modules

This means that even if one mechanical refrigeration module malfunctions during a shipment, the shipment can be carried out without any loss of temperature performance. Loss of a single battery module will not affect the container temperature performance, but it will reduce the autonomy time.

3.4 WALLS

The walls are composed of three layers:

- Sandwich panel (A)
- Insulation panel (B)
- Air distribution panel (C)

Damages such as scratches to the outer surface (D) of the sandwich panel do not affect the flight safety properties of the container. Light damages to the sandwich panel (A) do not affect the insulation performance of the container.

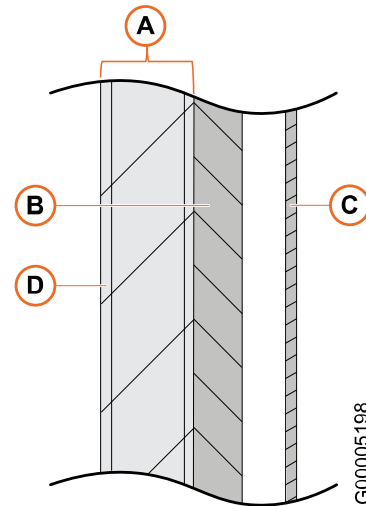

Fig. 8 Cross section of the container wall

3.5 OPERATING CONDITIONS

The following conditions must apply in order for the container to work properly when transporting temperature sensitive cargo:

- The cargo and the container must be pre-conditioned to the temperature set point.
- The container must have sufficient battery power for the intended duration and conditions of the shipment.
- The container must not be exposed to ambient temperatures outside the operational limits. Refer to **6. Technical specification**.

For information about the environmental conditions, refer to **1.2.1 Operating environment**.

4. USING THE CONTAINER

A shipment (B) is defined as all land and air transportation that is required to transfer a loaded container from the shipper site (A) to the consignee site (C).

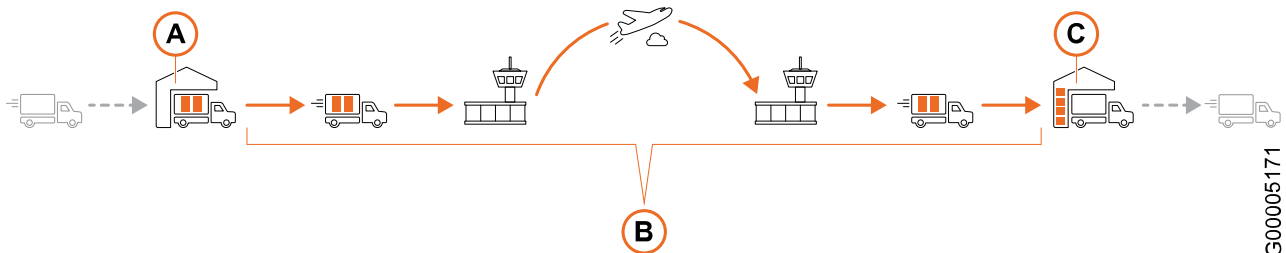

Fig. 9 The shipment chain

Chapters **4.1-4.3** contain three separate checklists, listing the actions to be performed when preparing a shipment, shipping the container, and finishing the shipment. Follow the applicable checklist, as defined below, to make sure that all necessary measures for a successful shipment are taken. The checklists contain references to relevant operating instructions.

- *Preparing a shipment:* Container handling at the shipper site, from receiving the empty container to handover of the loaded container.
- *Shipping:* Container handling during land transportation to and from the airport, and at the airport. To be performed by forwarders and airport personnel.
- *Finishing a shipment:* Container handling at the consignee site, from receiving the loaded container to handover of the empty container.

The checklists may be printed out to make sure that they are completed.

4.1 PREPARING A SHIPMENT

Before the shipment, the following must be performed:

- Pre-condition the cargo. Refer to **4.4.2.1 Pre-condition the cargo**.
- Pre-condition the container. Refer to **4.4.2.2 Pre-condition the container**.
- Confirm (on the display unit) that the container is within the required temperature range. A fixed green status indicator light indicates that the container is ready.
- Load and strap the cargo. Refer to **4.4.3 Loading the cargo**.
- Confirm that all doors and lids are closed and latched.
- Check that the battery level is sufficient for the shipment. If not, charge the container. Refer to **4.4.7.4 Check the battery level** and **4.4.4 Charging the container**.
- Take action on any active alarms and alerts. Refer to **4.4.7.5 View and address active alarms and alerts**.
- Make sure that the container is not wrapped. Refer to **4.4.5 Precautions during a shipment**.
- Make sure that the container is handled in ambient temperatures within the allowed operational limits, and limit exposure to other temperatures. Refer to **3.5 Operating conditions** and **6. Technical specification**.

For instructions on lifting and moving the container, refer to **4.4.1 Lifting and moving the container**.

4.2 SHIPPING

During the shipment, the following must be performed:

- Take action on any active alarms and alerts. Refer to **4.4.7.5 View and address active alarms and alerts.**
- Make sure that the container is not wrapped. Refer to **4.4.5 Precautions during a shipment.**
- Make sure that the container is handled in ambient temperatures within the allowed operational limits, and limit exposure to other temperatures. Refer to **3.5 Operating conditions** and **6. Technical specification.**
- If the duration of the shipment exceeds the specified autonomy for the container, or if the shipment is performed in challenging ambient conditions, consider charging the container whenever it is in a warehouse. Refer to **4.4.4 Charging the container.**
- Make sure that all doors and lids are closed and latched.
- Limit the time on the tarmac during aircraft loading (to avoid temperature extremes and direct sunlight).

For instructions on lifting and moving the container, refer to **4.4.1 Lifting and moving the container.**

4.3 FINISHING A SHIPMENT

After the shipment, the following must be performed:

- Take action on any active alarms and alerts. Refer to **4.4.7.5 View and address active alarms and alerts.**
- Unload the cargo.
- Turn the temperature control off. Refer to **4.4.7.6 Turn the temperature control off.**

For instructions on lifting and moving the container, refer to **4.4.1 Lifting and moving the container.**

For storage instructions, refer to **4.4.6 Storing the container.**

4.4 OPERATING INSTRUCTIONS

4.4.1 LIFTING AND MOVING THE CONTAINER

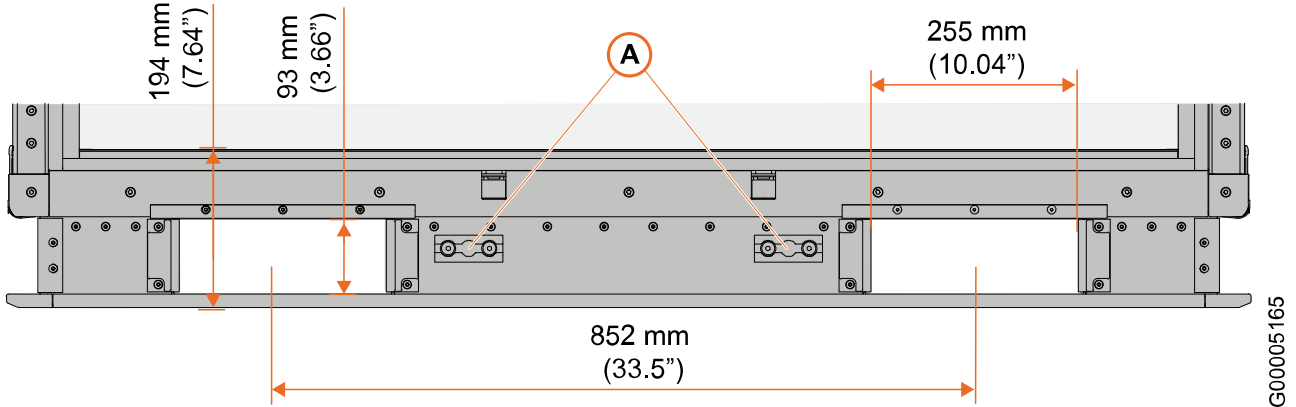

Fig. 10 Fork lift pockets and tie-down brackets

The container can be lifted using a forklift when empty or loaded. The forklift pocket center to center distance is 852 mm (33.5") and the forklift pocket width is 255 mm (10.04").

If the container must be pulled, the pulling device shall be attached to the tie-down brackets (A) on the base.



CAUTION!

Make sure that the charging cable is not connected to a power outlet before moving the container.



CAUTION!

Do not place the container on any electrical cables, such as the charging cables of other containers.



CAUTION!

Do not pull the container by the strap handles when the container is not placed on roller beds, as the strap handles may come loose.



CAUTION!

Do not drag the container against the ground, as this may cause damage to the container.

4.4.1.1 LIFT FROM THE SIDES

When lifting from the sides, the forklift pockets in the container base shall be used.

- Minimum length of forks when the container is empty: 1200 mm (47.2")
- Minimum length of forks when the container is loaded: 1200 mm (47.2")

4.4.1.2 LIFT FROM THE FRONT (DOOR SIDE)

When lifting from the front, the forklift pockets in the container base shall be used.

CAUTION!
Risk of crush injury! Due to the weight of the refrigeration system at the rear, it is not recommended to lift the container from the front.

- Minimum length of forks when the container is empty: 2200 mm (86.6")
- Minimum length of forks when the container is loaded: 2200 mm (86.6")

4.4.1.3 LIFT FROM THE REAR (MACHINE ROOM SIDE)

When lifting from the rear, the forklift pockets in the container base shall be used.

- Minimum length of forks when the container is empty: 1600 mm (63")
- Minimum length of forks when the container is loaded: 1600 mm (63")

4.4.1.4 LIFT WITH AN ELECTRIC PALLET JACK

When lifting with an electric pallet jack, the pallet jack forks shall be placed underneath the container base and not inside the forklift pockets.

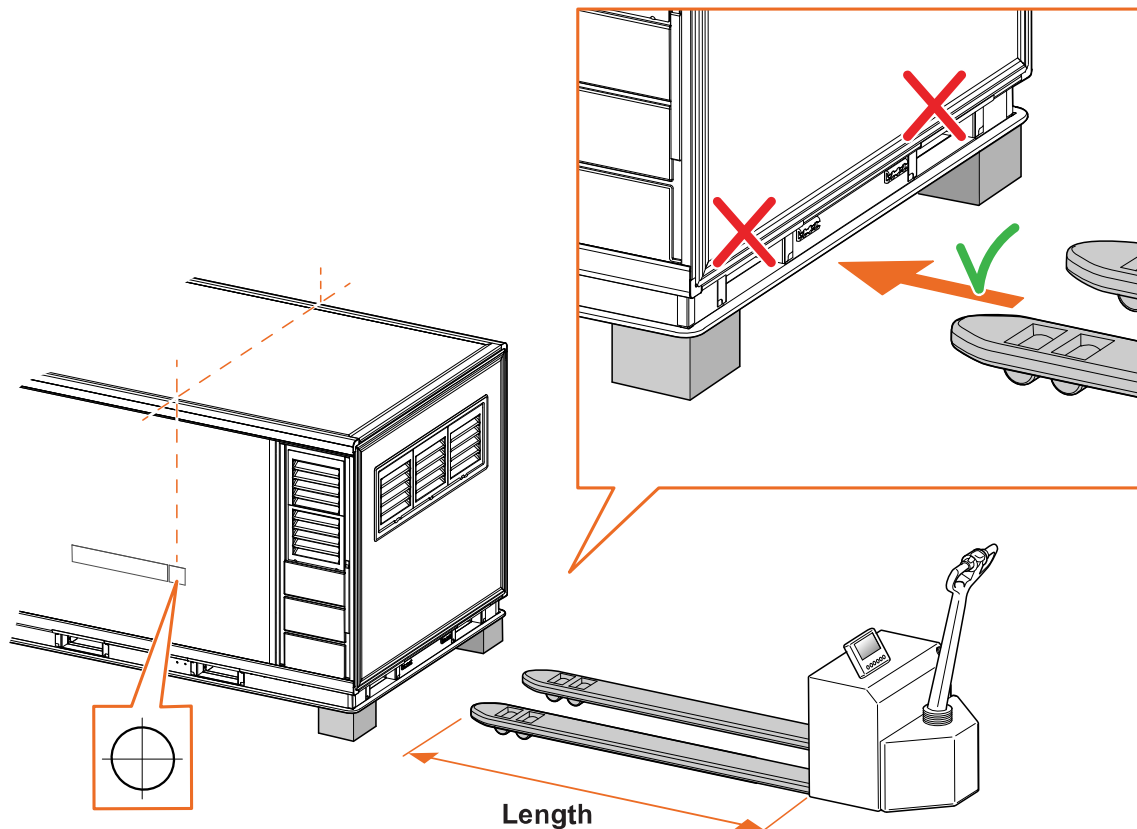

Fig. 11 How to lift the container with an electric pallet jack

G00005164

↓

⚠ WARNING!

Risk of crush injury! The container weighs approximately 880-3175 kg (unloaded-maximum loaded). Make sure that the pallet jack is wide enough to keep the container stable.

ℹ NOTE!

Since the center of gravity is located on the rear side of the container, it is recommended to lift the container from that side.

Use an electric pallet jack or electric walkie rider with the following properties:

- Minimum rated lifting capacity: equal to the container total gross weight
- Minimum length of forks: 2440 mm (96")

Place the container on supports to remove the electric pallet jack.

4.4.1.5 USE A ROLLER BED SYSTEM

1. Use the strap handles at the corners of the container to handle the container on roller beds.

⚠ WARNING!

Risk of crush injury! The container weighs approximately 880–3175 kg (unloaded-maximum loaded). Do not stand in front of a moving container.

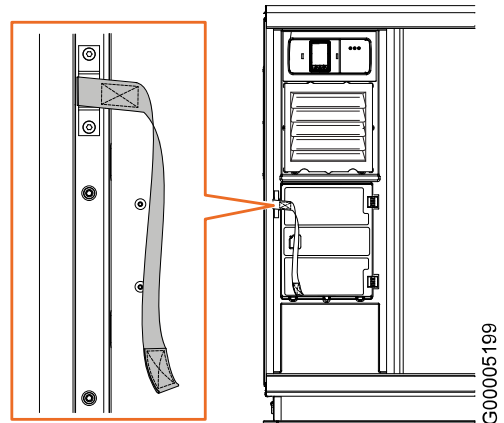

Fig. 12 Roller bed handling

4.4.2 PRE-CONDITIONING THE CARGO AND THE CONTAINER

4.4.2.1 PRE-CONDITION THE CARGO

The container is designed to maintain the cargo at the cargo space temperature set point, but not to cool or heat the cargo.

The cargo must be pre-conditioned to the cargo space temperature set point before it is loaded into the container. This includes packaging material, such as for example shrinkwrap, and temperature loggers. Improper pre-conditioning will affect the container's ability to maintain the necessary cargo temperature.

4.4.2.2 PRE-CONDITION THE CONTAINER

The container must be pre-conditioned to the cargo space temperature set point before the cargo is loaded. Improper pre-conditioning will affect the container's ability to maintain the necessary cargo temperature.

There are two ways of pre-conditioning the container:

- Using the internal pre-conditioning program
- Using a temperature controlled room

When using the internal pre-conditioning program, the pre-conditioning can be started immediately, or set to be completed within a specified number of hours (2–72 hours).

4.4.2.2.1 Pre-condition using the internal pre-conditioning program

Pre-conditioning to +5 °C (+41 °F) at an ambient temperature of -5 to +25 °C (+23 to 77 °F) takes maximum one hour. Pre-conditioning outside this ambient temperature range will take more time.

If the container is connected to a power outlet during pre-conditioning, no battery power is consumed.

1. Make sure the container doors are closed.

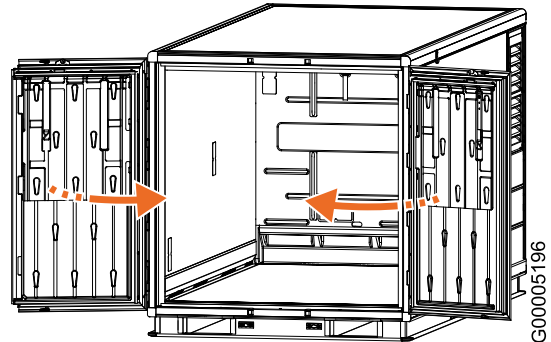









Fig. 13 Close the doors

2. On the shipment status overview, press  to enter **Container Settings**.
3. Select **Set Temperature**.

 **NOTE!**

The **Set Temperature** screen is active for one minute. If the display returns to the shipment status overview before the new set temperature has been confirmed, the setting is not saved.

4. Set the applicable temperature using  and  and press  to confirm. A prompt to start pre-conditioning will be shown.
5. To start the pre-conditioning immediately: Select **Now** and press  to initiate the pre-conditioning. The display shows **Temperature control PRE-CONDITIONING**.
6. To start the pre-conditioning later:
 - 6a. Select **Set Timer**.
 - 6b. Set the total number of hours remaining until the pre-conditioning shall be completed, using  and . The timer interval is 2–72 hours.

- 6c. Press ✓ to confirm the setting. The display shows **Temperature control PRE-CONDITIONING** and the estimated remaining time until the pre-conditioning is finished. The format is hh:mm, i.e. the remaining time in hours and minutes.



G00005832

Fig. 14 The remaining pre-conditioning time

- 7. Wait until **Temperature control ON** is shown on the display before loading any cargo.

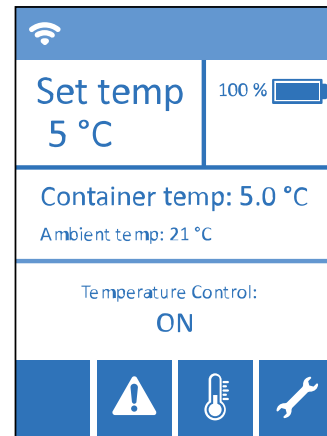

G00005872

Fig. 15 Pre-conditioning finished

4.4.2.2.2 Pre-condition using a temperature controlled room

The pre-conditioning using a temperature controlled room can be performed with the refrigeration system turned on or off. Pre-conditioning with the refrigeration system turned off saves battery power, but must be completed by running the internal pre-conditioning program to activate the container temperature control. As the container already holds the correct temperature, it will not take long for the pre-conditioning program to finish.

- 1. Place the container in a temperature controlled room that holds the desired temperature.

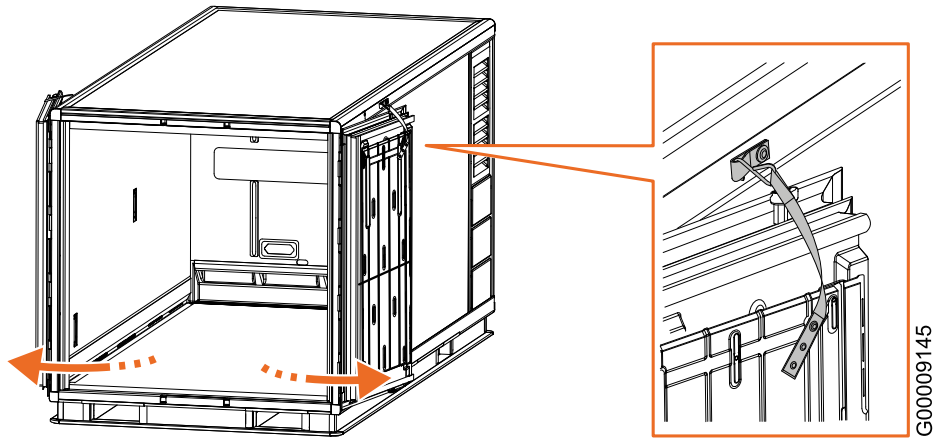







Fig. 16 Open and lock the doors in the opened position

2. Open the doors to the cargo space and lock them in the opened position using the door straps.
3. If the pre-conditioning shall be performed with the temperature control turned on:
 - 3a. On the shipment status overview, press  to enter **Container Settings**.
 - 3b. Select **Set Temperature**.





 **NOTE!**

The **Set Temperature** screen is active for one minute. If the display returns to the shipment status overview before the new set temperature has been confirmed, the setting is not saved.

- 3c. Set the applicable temperature using  and  and press  to confirm.
- 3d. When prompted to start pre-conditioning, select **Now** and press  to initiate the pre-conditioning.
4. Allow up to 1 hour for container pre-conditioning. The display will show **Temperature control PRE-CONDITIONING** during the process. Wait until the text changes to **Temperature control ON** before loading the cargo.
5. If the pre-conditioning is performed with the temperature control turned off, make sure that the container has reached the correct temperature, then run the internal pre-conditioning program:
 - 5a. On the shipment status overview, press  to enter **Container Settings**.
 - 5b. Select **Set Temperature**.

 **NOTE!**

The **Set Temperature** screen is active for one minute. If the display returns to the shipment status overview before the new set temperature has been confirmed, the setting is not saved.

- 5c. Set the applicable temperature using  and  and press  to confirm.
- 5d. When prompted to start pre-conditioning, select **Now** and press  to initiate the pre-conditioning.
- 5e. Wait until **Temperature control ON** is shown on the display before loading the cargo.

4.4.3 LOADING THE CARGO

Load the cargo in a temperature controlled area.

1. Make sure that both the cargo and the container are properly pre-conditioned. Refer to **4.4.2 Pre-conditioning the cargo and the container.**
2. Load the cargo on pallets to allow proper airflow through the pallet underneath the cargo.

⚠ CAUTION!

If the cargo is wrapped, make sure that the pallet is not covered, as this would obstruct the airflow along the floor beneath the cargo.

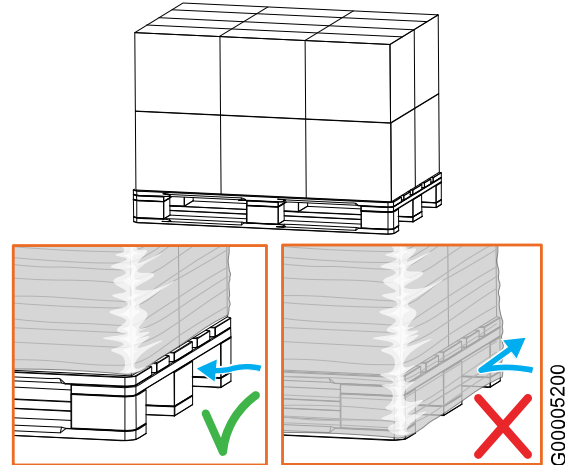

Fig. 17 Allow airflow through the pallet

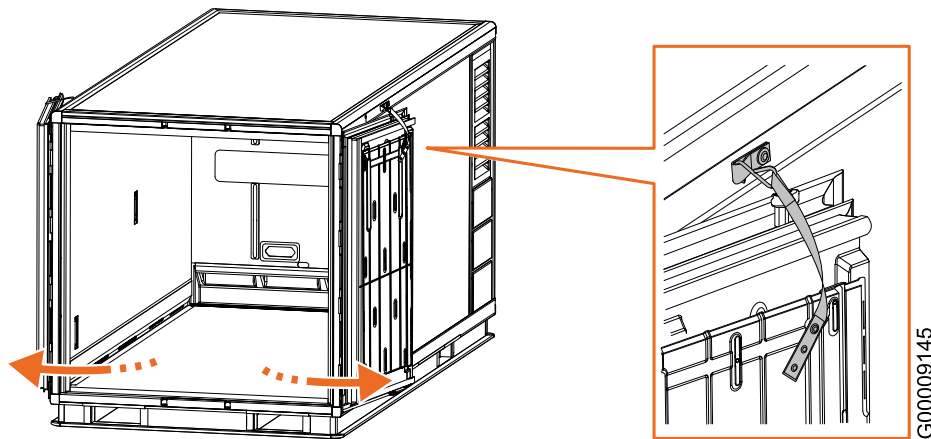
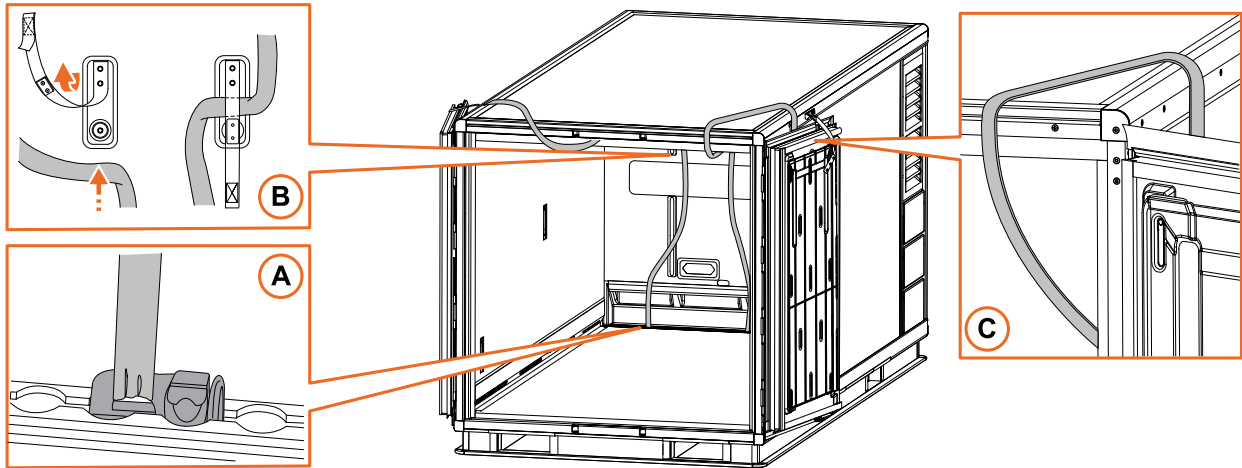

Fig. 18 Open and lock the doors in the opened position

3. Open the doors to the cargo space and lock them in the opened position using the door straps.





G00005195

Fig. 19 Fasten and suspend cargo straps in the cargo space

4. Consider fastening air cargo straps to the tie-down tracks (A) at the rear of the cargo space, temporarily suspending them in straps (B) attached to the partition wall, and placing the air cargo straps (C) over the container roof until the cargo has been loaded. It may be hard to reach the rear tie-down tracks with the cargo in place.
5. Load the cargo into the container, distributing the cargo weight evenly.

i NOTE!

Cargo loading shall be done in a temperature controlled area as much as possible. If there are limitations at the facility, make sure to minimize the time the container doors are open outside temperature controlled areas.

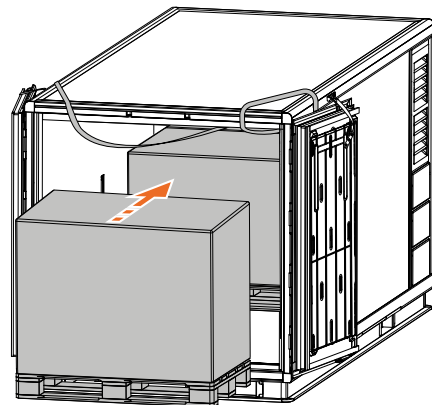

G00005193

Fig. 20 Load the cargo



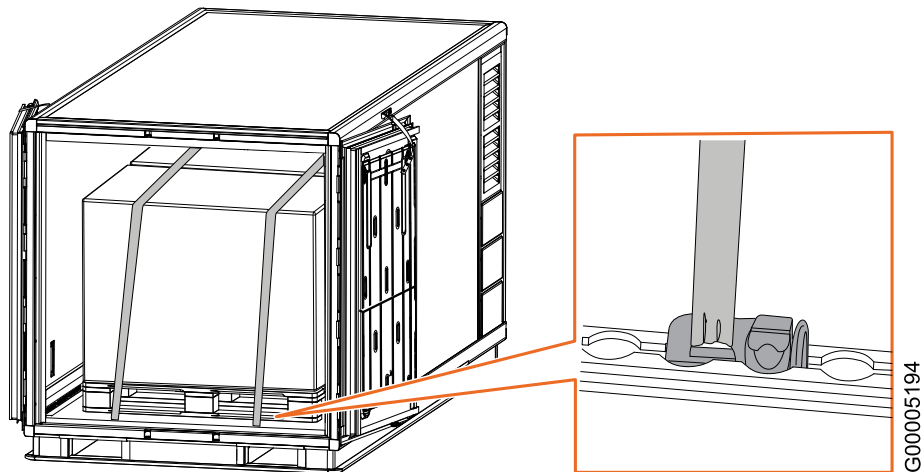

Fig. 21 Secure the cargo

- Secure the cargo to the tie-down tracks inside the container using tie-down studs and straps.

⚠ CAUTION!

Cargo that is not properly strapped may shift and cause cargo and container damage.

- Close and lock the doors. If applicable, secure at least the right hand door with a seal.

⚠ WARNING!

Before closing the doors, make sure that nobody is inside the cargo space.

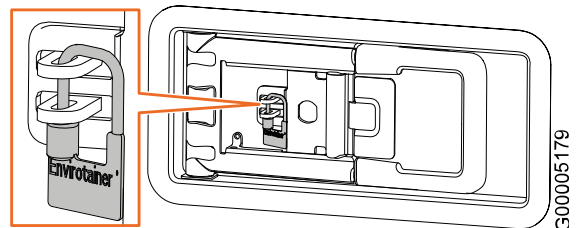

Fig. 22 Close, lock and seal the doors

- Place any shipping documents or checklists in the container document pouch, and put any shipping labels on the allocated space "Place stickers here".

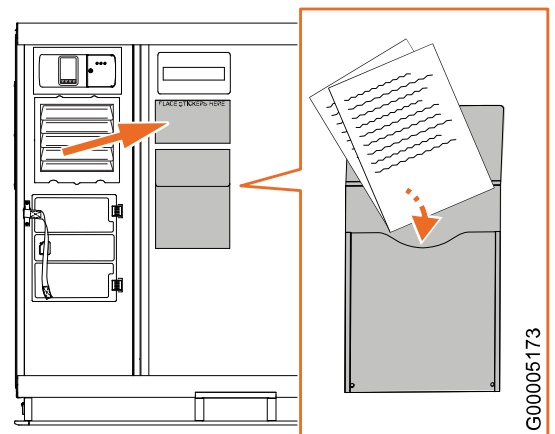

Fig. 23 Add shipping documents and labels

4.4.4 CHARGING THE CONTAINER

NOTE!

It is recommended to keep the container battery level above 20%. An alert will be triggered if the level drops below 20%.

For optimal charging, make sure that the ambient temperature is between +5 and +25 °C (+41 to +77 °F). In temperatures outside this range the charging capacity of the battery may be reduced and the charging time may be increased. Avoid charging outside the temperature range -20 °C to +40 °C (41 °F to +104 °F).

For information on the maximum charging time and power consumption, refer to **6. Technical specification**.

A 100-240 V AC +/-10% power supply requires a circuit protection capability of minimum 10 A.

4.4.4.1 SAFETY PRECAUTIONS

WARNING!

Do not charge the container inside an aircraft, as the container is not certified for this.

WARNING!

Risk of electric shock! Do not charge the container outdoors or in damp and/or humid environments.

WARNING!

Risk of electric shock! Visually inspect the charging cable, and any adapter used, for any abnormalities before connecting it to a power outlet. Connectors shall be inspected for residual water or other contamination. Make sure that the power outlet in the building is provided with protective earth before connecting the charging cable.

CAUTION!

Do not move the container during charging.

CAUTION!

Avoid use of additional extension cable as far as possible. If the use of extension cable is required, use as short cable as possible and make sure that the cable is rated for 16 A or more.

CAUTION!

The initial peak current during charging may be high, with additional strain on the power source fuses. If the container is connected to a sensitive power grid it may cause flickering in the facility. Do not connect more than one container per circuit to avoid overload of the power source fuse. Recommendation:

- For outlets rated for 200 V or more, the fuse should be rated for 10 A.
- For outlets rated for less than 200 V, the fuse should be rated for 20 A.

4.4.4.2 THE CHARGING UNIT

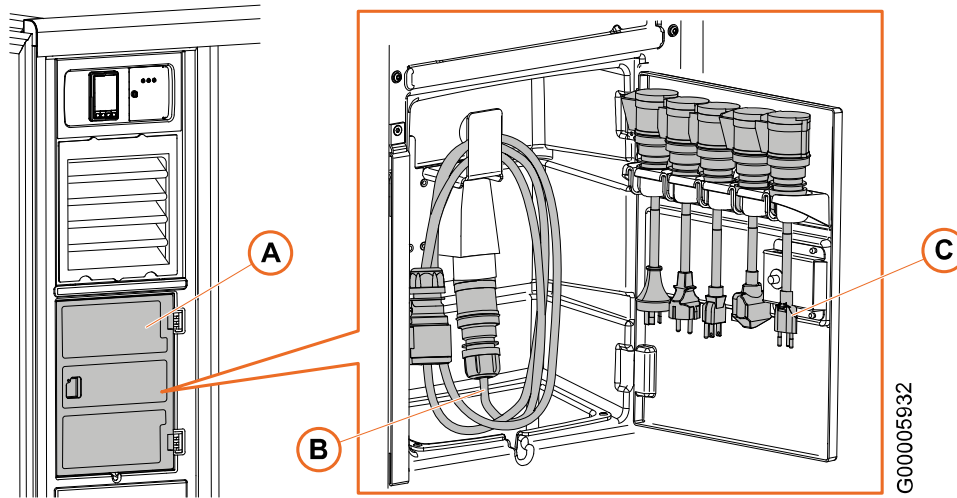

Fig. 24 The charging unit

The charging unit (A) is used for charging the internal battery modules of the container. It contains a charging cable (B) and the following selection of adapters (C):

Table 3 Adapters included

Adapter	Specification	Part number
Swiss SEV 1011	10 A, 250 V	P/N 807M
BS 1363	13 A, 250 V	P/N 807P
Nema 5–15P	15 A, 125 V	P/N 807Q
CEE 7/7	16 A, 250 V	P/N 807R
AS/NZS 4417	10 A, 250 V	P/N 807S

4.4.4.3 CHARGE THE CONTAINER

1. Open the door of the charging unit and take out as much of the charging cable as needed.

⚠ WARNING!
Inspect the connector, in the loose charging cable end, for residual water or other contamination.

ℹ NOTE!
It is allowed to use another charging cable than the one provided. Make sure that the substitute cable is rated for at least 16 A. Unplug the provided cable from the socket and insert the substitute charging cable. Provided adapters may be inserted directly into the socket if necessary.

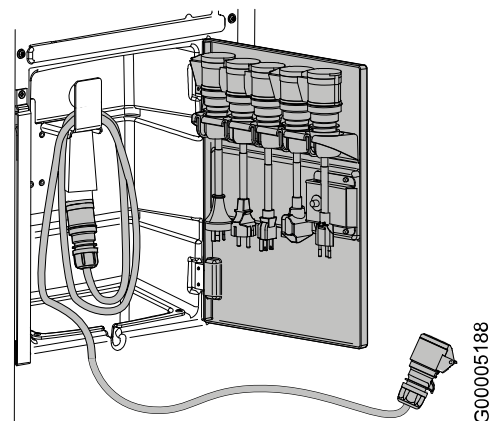

Fig. 25 Take out the charging cable



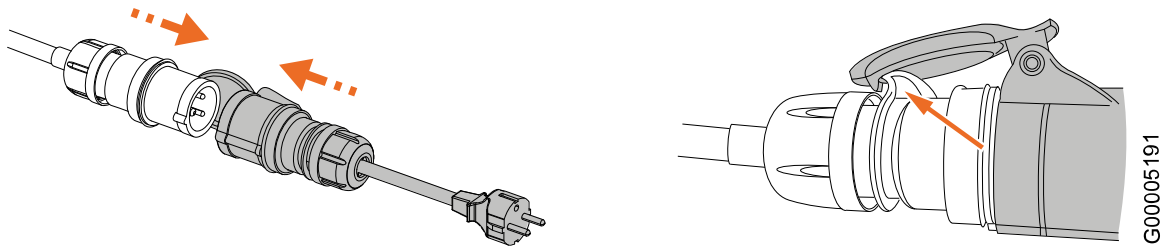

Fig. 26 Connect an adapter

2. If necessary, connect an adapter to the charging cable. The adapters are found on the inside of the charging unit door.

Additional adapters can be ordered, refer to **4.4.4.4 Order additional charging adapters**.

NOTE!

Make sure that the hook on the charging cable connector locks into the lid of the adapter connector.

3. Connect the plug or adapter to the power outlet. The green status indicator light flashes and the display is lit for a minute. The display shows **Charging ongoing, currently at [XX] %**. After one minute the display enters sleep mode but the green status indicator light keeps flashing to indicate that the charging is ongoing.

CAUTION!

Tripping hazard. Make sure that any excess cable is safely stowed away in the charging unit.

4. When the green status indicator light changes from flashing to fixed and the display shows **Container fully charged**, the charging is completed. Disconnect the plug/adapter from the power outlet.
5. If applicable, disconnect the adapter from the charging cable and return the adapter to the holder on the inside of the charging unit door. Make sure that all five adapters are in place.

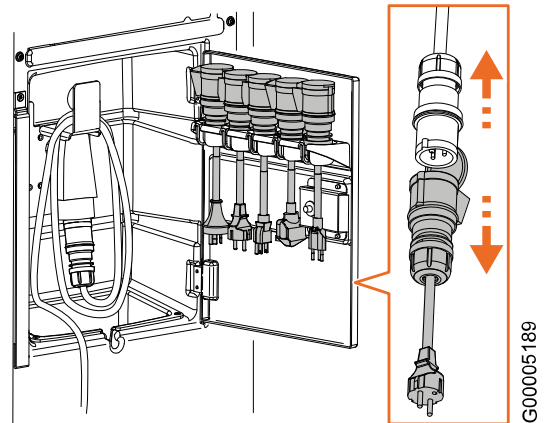

Fig. 27 Disconnect the adapter



- Stow the charging cable in the charging unit and close the door properly.



CAUTION!

Direct the connector end downwards as illustrated.



NOTE!

Make sure to put the provided charging cable back if another cable was used for charging.

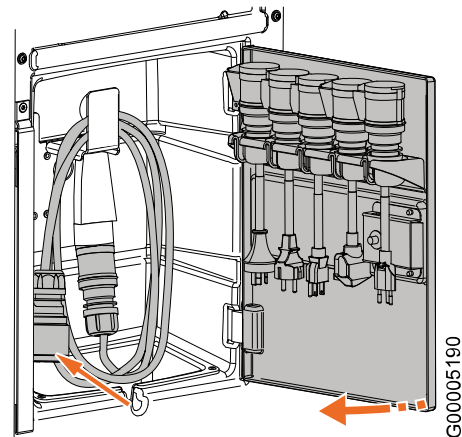

Fig. 28 Stow the charging cable and close the door

4.4.4.4 ORDER ADDITIONAL CHARGING ADAPTERS

The following additional charging adapters can be ordered from Envirotainer:

Table 4 Additional adapters available for order

Adapter	Specification	Part number
British Standard 546	15A, 3 pins	P/N 807W
NEMA 6-15R	15A, 250V	P/N 807X
NEMA L15-30P	30A, 250V	P/N 807Y
Danish SRAF 1962/DB 16/87	10A, 250V, K-plug	P/N 807Z

Place an order by sending an e-mail, containing the following information, to logisticspareparts@envirotainer.com:

- Part number and quantity of the desired adapter(s)
- Customer name and contact person, including contact details
- Billing address
- Delivery address, if different from the billing address
- If applicable, the name of the preferred forwarding agent, along with customer number. It is however recommended to use Envirotainer's forwarding agent.

4.4.5 PRECAUTIONS DURING A SHIPMENT

⚠ CAUTION!

Do not wrap the container. If the container is wrapped the air inlets and outlets are blocked and the container may overheat.

If required, disable the connectivity manually. Refer to **4.4.7.7 Disable connectivity**.

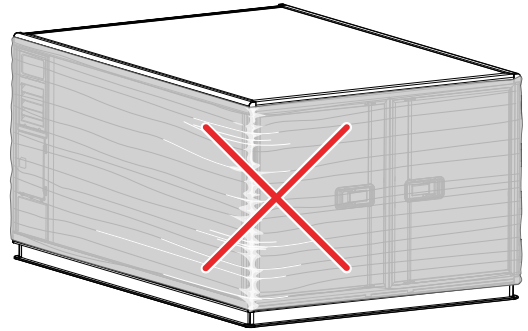

G00005162

Fig. 29 Do not wrap the container

4.4.6 STORING THE CONTAINER

⚠ CAUTION!

For personal safety and to avoid damage to the container: Do not store any containers, cargo or other items on top of the container.

Store the container on flat ground in a temperature of -32 °C to +49 °C (-25.6 °F to 120.2 °F).

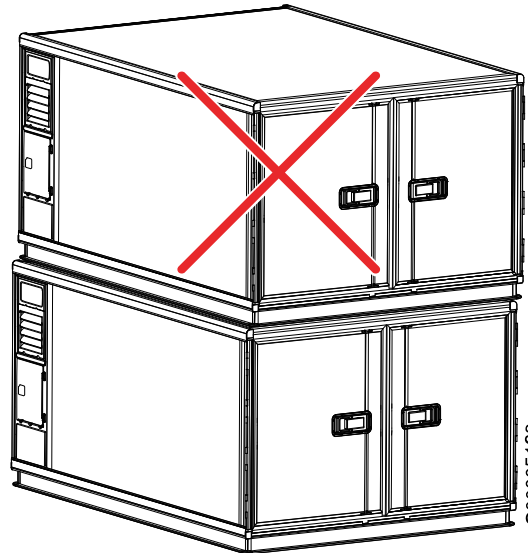

G00005163

Fig. 30 Do not store anything on top of the container

4.4.7 OPERATING THE DISPLAY UNIT

NOTE!

If the display is dark, the display is in sleep mode, but the container is operating.
The container has no power or on/off button, but the temperature control can be turned on/off.

4.4.7.1 THE DISPLAY UNIT

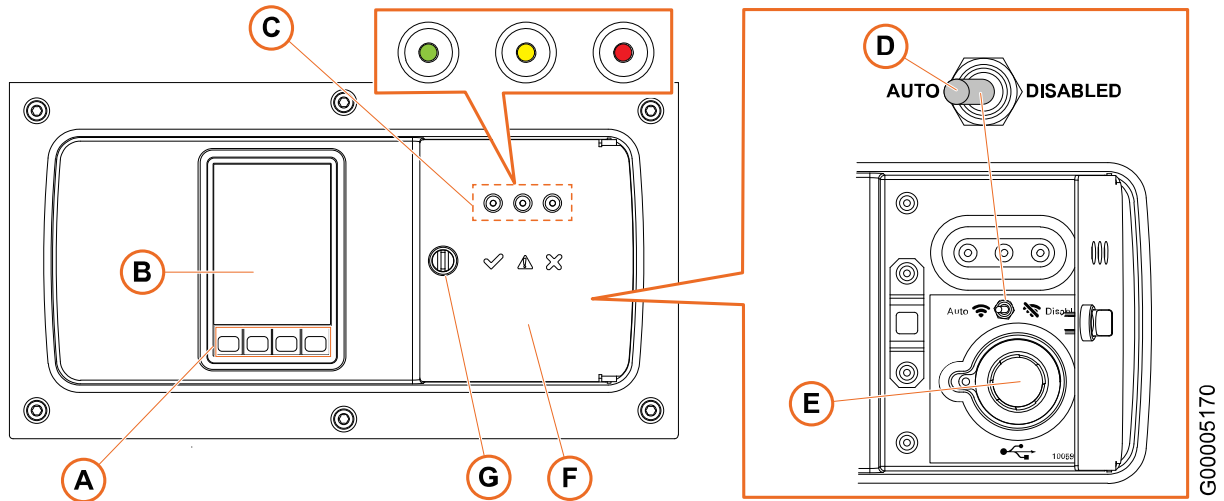

Fig. 31 Overview of the display unit

Table 5 Display unit features

Pos	Description	Pos	Description
A	Buttons	E	USB connector (not in use)
B	Display	F	Hatch
C	Status indicator lights	G	Locking knob
D	Connectivity switch		

4.4.7.1.1 Display

The default view when the display is turned on is the shipment status overview. If there is an active alarm or alert, the shipment status overview is temporarily replaced by an alarm/alert message.

Refer to **4.4.7.5 View and address active alarms and alerts**.

The display enters sleep mode one minute after the last interaction, and wakes up at the touch of a button. If an alarm or alert is activated when the display is in sleep mode, the display is automatically lit and stays lit for 90 seconds.

The buttons underneath the display are used to navigate in the menu and settings.

If preferred, the display may be locked for input. Refer to **4.4.7.8 Lock and unlock the display unit for input**.

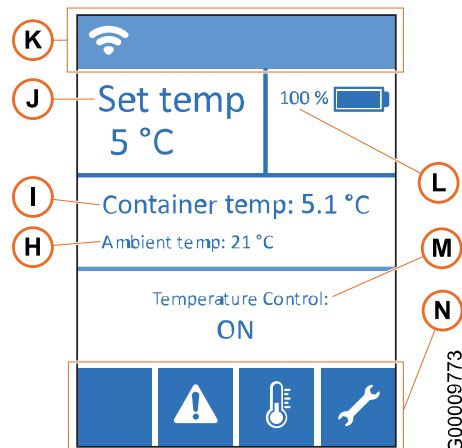

Fig. 32 The shipment status overview

The shipment status overview contains the following information (**Fig. 32** and **Table 6**):

Table 6 Information on the shipment status overview

Pos	Description	Pos	Description
H	Current ambient temperature (Celsius)	L	Remaining battery level in percent
I	Current temperature in the cargo space (Celsius)	M	Container status
J	Current set temperature (Celsius)	N	Button icons, see Table 7
K	Indicator icons, see Table 8		

Table 7 and **Table 8** explain the icons that can occur on the display. shows the menu structure of the display unit.

Table 7 Button icons



















Icon	Description	Icon	Description	Icon	Description
	Container settings		Decline		Up
	Maintenance (pin code required)		Return to previous menu		Down
	View alarms		Forward		
	Accept		Back		

Table 8 Indicator icons

Icon	Description	Icon	Description	Icon	Description
	Pre-conditioning in progress		Connectivity in automatic flight detection mode.		Logged into maintenance (pin code required)
			No reception / Reception		
	Battery level indicator		Connectivity disabled (via connectivity switch)		Display unit locked for input
	Connected to power outlet (even if not charging) (filled bar related to %)				





*The action is only visible if an interaction is possible in the current mode. For example, when the container is pre-conditioned to the set temperature it is only possible to shut off the temperature control, not change the set temperature or trigger pre-conditioning. To change the set temperature, the temperature control must be shut off first, then the container must be pre-conditioned to the new set temperature.

4.4.7.1.2 Buttons

The buttons on the display unit have different applications depending on which menu is currently active on the display - see the button icon above the button. For descriptions of the button icons, refer to **Table 7**. Any of the buttons can be used for waking the display up from sleep mode.

4.4.7.1.3 Status indicator lights

Table 9 Status indicator lights

Color	Explanation and action
All indicator lights off 	Temperature control is deliberately turned off either before, during or after lease. No action required
Green (fixed) 	The container is working properly. No action is required.
Green (flashing) 	The container is working properly, and is performing a task to prepare for shipment. No action is required.
Yellow 	An alert has been triggered. Actions are required to mitigate emerging risks for the shipment. Refer to the display for more information.
Red 	An alarm has been triggered. One or more of the refrigeration system components are malfunctioning, and the shipment is at risk. If the container is maintaining temperature and charging, hold the cargo in the cargo space and arrange to replace the container. If not, move the cargo to a temperature controlled environment until the container can be replaced. Refer to the display for more information.

For more information about alarms and alerts, refer to **5. Troubleshooting**.

4.4.7.1.4 Connectivity switch

The container is provided with connectivity equipment for wireless transmission of shipment data. It has a built in flight detection that automatically turns the connectivity off when the container comes close to an aircraft, and turns it back on again when the container is at a safe distance from the aircraft. If required, the connectivity can also be disabled manually using a connectivity switch, to enable transport on an aircraft for which the operator has not approved the use of equipment based on automatic flight detection.

Refer to **4.4.7.7 Disable connectivity**.

When the connectivity is turned off, either automatically or using the switch, the container records shipment data. The recorded data will be available once the connectivity is on again.

4.4.7.2 WAKE THE DISPLAY UP FROM SLEEP MODE

1. Press any button on the display unit once.

4.4.7.3 SET THE TEMPERATURE

 **NOTE!**

The temperature can only be set before the start of the pre-conditioning. When the container is pre-conditioned, the set temperature is locked and cannot be changed. To restart the temperature setting, the temperature control needs to be shut-off. Refer to **4.4.7.6 Turn the temperature control off**.

1. On the shipment status overview, press  to enter **Container Settings**.



2. Select **Set Temperature**.

NOTE!

The **Set Temperature** screen is active for one minute. If the display returns to the shipment status overview before the new set temperature has been confirmed, the setting is not saved.

- 3. Set the applicable temperature using **↑** and **↓**.
- 4. Press **✓** to confirm the temperature setting.

4.4.7.4 CHECK THE BATTERY LEVEL

The battery level is shown on the shipment status overview. If the display is in sleep mode, press any button to wake it up.

Note that the remaining operating time varies depending on the set temperature and the ambient conditions. The operating time increases if the ambient temperature is close to the container set temperature.

For information about operating time, refer to **6. Technical specification**.

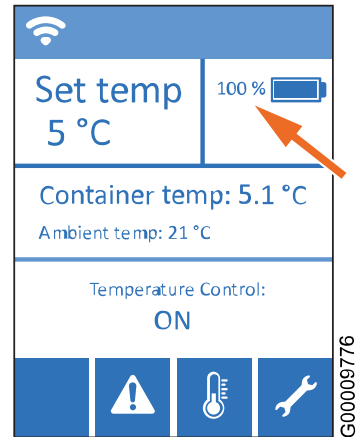

Fig. 33 The battery level

4.4.7.5 VIEW AND ADDRESS ACTIVE ALARMS AND ALERTS

When there are active alarms or alerts, the button  on the shipment status overview is orange.

1. On the shipment status overview, press .

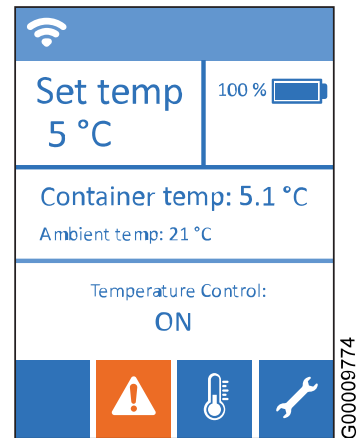





Fig. 34 View active alarms

2. Toggle through the active alarms and alerts using  and .
3. Address the active alarms and alerts in accordance with the information given. Refer to **5.3 Alarms** and **5.2 Alerts** for more information.

 **NOTE!**

The alarm or alert will be visible until the container has sensed that the alarm or alert has been resolved.



4. To return to the shipment status overview, press .

 **NOTE!**

An alarm or alert that has been viewed, but not addressed, is still active and pending action. The button  on the shipment status overview will remain orange.

4.4.7.6 TURN THE TEMPERATURE CONTROL OFF

The container has no power or on/off button. Instead, the temperature control should be turned off after the finished shipment (when the cargo has been removed from the container) to save battery power and prolong the battery lifespan.

1. On the shipment status overview, press  to enter **Container Settings**.
2. Press  to select **Temp Control Off**. The display will show the text in **Fig. 35**.
3. Press and hold buttons **A** and **B** simultaneously for 3 seconds. The time is counted down while holding. Then **Temperature Control OFF** is shown on the display.

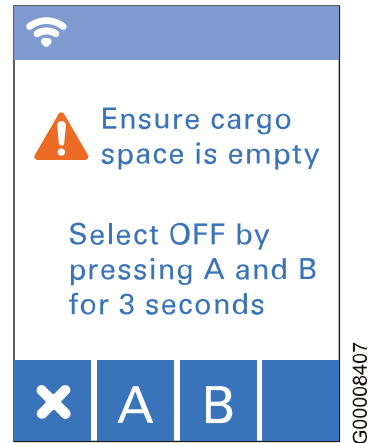

Fig. 35 Turn Temperature Control OFF

To turn the temperature control on, follow the instructions in **4.4.2.2.1 Pre-condition using the internal pre-conditioning program**.

4.4.7.7 DISABLE CONNECTIVITY

When the connectivity is in automatic flight detection mode, the connectivity is automatically disabled when the container comes close to an aircraft. If required, the connectivity can also be disabled manually at any time:

1. Open the lid to the right of the display.

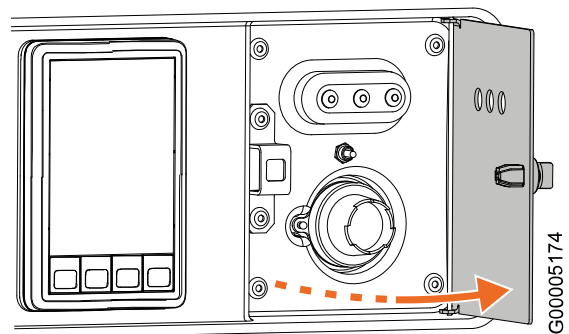

Fig. 36 Open the display lid



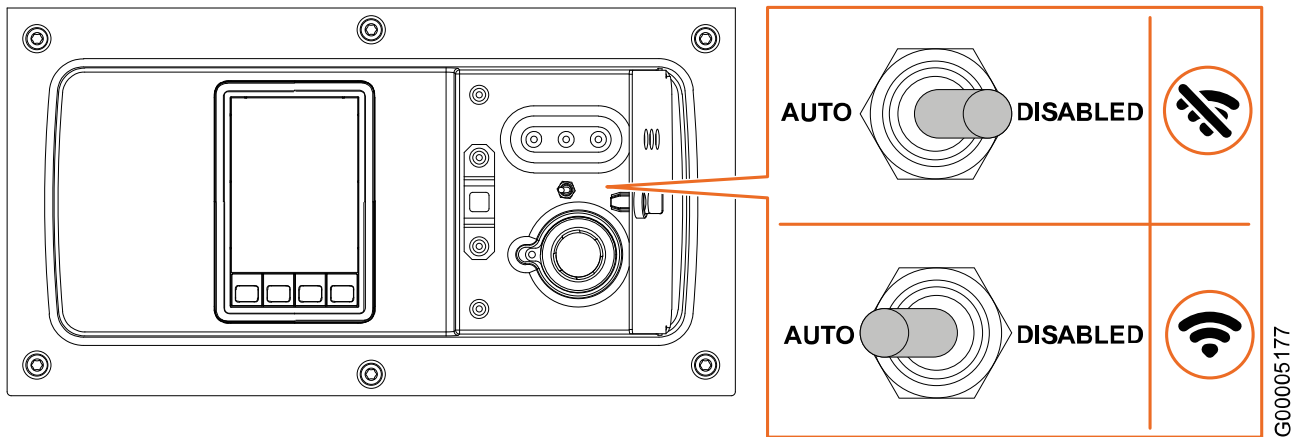

Fig. 37 Connectivity switch

2. Toggle the connectivity between automatic flight detection mode and disabled:
 - Connectivity switch towards **DISABLED**: The connectivity is disabled. The top icon in **Fig. 37** is shown on the display.
 - Connectivity switch towards **AUTO**: The connectivity is in automatic flight detection mode. The lower icon in **Fig. 37** is shown on the display (empty if there is no reception, filled if there is reception). If the connectivity switch is switched towards **AUTO** while the container is close to an aircraft, the connectivity will not be turned on until the container has left the aircraft.
3. Close the lid. If preferred, seal the lid with a sealing sticker.

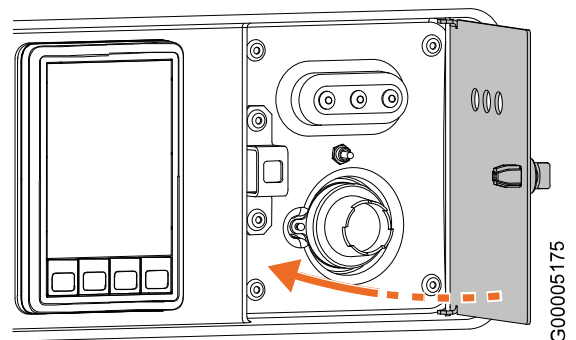



Fig. 38 Close the lid

4.4.7.8 LOCK AND UNLOCK THE DISPLAY UNIT FOR INPUT

1. On the shipment status overview, press and hold  for three seconds. The lock icon will be visible on the display. Repeat the step to unlock the display unit.

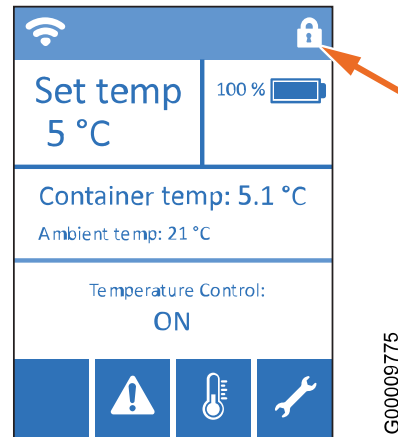



Fig. 39 Locked display



5. TROUBLESHOOTING

These troubleshooting tables can be used when the display unit indicates an alarm or alert, or when there is a problem with the container. If a solution can not be found, replace the container. Meanwhile, place the cargo in a temperature controlled area.

5.1 INFORMATION MESSAGES

A flashing green light  indicates that the container performs a task to prepare for shipment. No action is required. The ongoing task is stated on the display.



A fixed green light  indicates that the container is working properly. No action is required.

	Information message	Explanation	Solution	Reference
	Preconditioning on-going	Pre-conditioning is in progress. The cargo space has not yet reached the set point temperature.	When the green indicator light changes from flashing to fixed the pre-conditioning is finished. The display unit will change text to Temperature control: ON.	
	Charging on-going, currently at [XX] %	Charging is in progress.	When the green indicator light changes from flashing to fixed the charging is finished. Until the charging cable is disconnected from the power outlet, the display unit will show Container fully charged.	





5.2 ALERTS

An active alert is indicated by a yellow indicator light  on the display unit.

The yellow indicator light  means that actions are required to mitigate emerging risks for the shipment. Perform the corrective action stated on the display. The alert will disappear when the container senses that the alert has been resolved.

	Alert	Explanation or possible cause	Solution	Reference
	Battery depleted. Please connect charging cable.	Battery level 0%. The refrigeration system has shut down.	Charge the container.	4.4.4 Charging the container
	Battery malfunction, maximum [XX]% energy level available	Autonomy time reduced to stated (XX) percentage (e.g. 75% of full autonomy available).	Look at to stated battery level on display unit and charge the container when necessary.	4.4.4 Charging the container



→

	Alert	Explanation or possible cause	Solution	Reference
	Cargo space door open, please close door	A door sensor has detected that a door is open.	Close the door.	
	Cargo space temperature outside of set temperature. Make sure that doors are closed and check ambient temperature.	The cargo space temperature is higher or lower than the set temperature including the tolerance.	Make sure that the doors are closed and check the ambient temperature.	
	High ambient temperature, please move container to colder location	The container is located in a higher ambient temperature than it is designed for.	Move the container to a colder location.	Refer to 6. Technical specification.
	Low ambient temperature, please move container to warmer location	The container is located in a lower ambient temperature than it is designed for.	Move the container to a warmer location.	
	Low battery level, please connect charging cable	The battery level is below 20%.	Charge the container.	Refer to 4.4.4 Charging the container

5.3 ALARMS

An active alarm is indicated by a red indicator light  on the display unit.

The red indicator light  means that one or more of the refrigeration system components are malfunctioning, and the shipment is at risk. If the container is maintaining temperature and charging, hold the cargo in the cargo space and arrange to replace the container. If not, move the cargo to a temperature controlled environment until the container can be replaced. Refer to the display for more information.

	Alarm	Explanation or possible cause	Solution	Reference
	All cargo space sensors missing, container performance reduced	One or more of the refrigeration system components are malfunctioning, and the shipment is at risk. The container is in limp home mode and will continue to control the cargo space temperature but at limited performance.	Stop the current shipment and replace the container. If required, move the cargo to a temperature controlled area.	
	Container charging failure.	There is a problem in the charging of the battery modules. The refrigeration system is still working.	Assess if the battery charge level is enough to continue the shipment. If not, replace the container.	

→

	Alarm	Explanation or possible cause	Solution	Reference
●	Container climate control failure, replace container	One or more of the refrigeration system components are malfunctioning, and the shipment is at risk.	Stop the current shipment and replace the container. If required, move the cargo to a temperature controlled area. If the container has arrived at destination and can maintain the temperature, ask the consignee to pick up the cargo as soon as possible.	
●	Container system failure, abort shipment			

5.4 HARDWARE

This chapter can be used if there is a need to troubleshoot the container from a hardware perspective.

Problem	Possible cause	Solution	Reference
The display on the display unit is dark, but an indicator light is lit.	The display is in sleep mode to preserve energy.	Press any button to light the display. If the indicator light is green, Shipment status overview is shown. If the indicator light is yellow or red, Alarm/Alert Actions is shown.	4.4.7.2 Wake the display up from sleep mode
The buttons are unresponsive, the display on the display unit is dark and no indicator light is lit.	The batteries are depleted.	Connect the container to a power outlet to charge the batteries. An indicator light should light up. If no indicator light lightens up, there may be an issue with the power outlet, refer to the problem "The batteries do not charge". If an issue with the display is suspected, contact customer support.	4.4.4 Charging the container and 1.4 Contact
The batteries do not charge.	The power outlet does not supply power.	Change to another power outlet and/or check the fuses in the facility.	
	The fuse is blown in the power supply central of the facility.	Change the fuse.	
	The adapter is broken.	If available, use a spare adapter.	
	The charging cable is damaged (visually inspect the cable).	Use an alternative charging cable.	

→

Problem	Possible cause	Solution	Reference
The display states that the door is open, but the door is closed.	The door is not correctly closed.	Make sure the door is closed. If it is closed, contact customer support.	<u>1.4 Contact</u>
	The door sensor may be faulty.	Contact customer support.	<u>1.4 Contact</u>
The display states that the door is closed, but the door is open.	The door sensor may be faulty.	Contact customer support.	<u>1.4 Contact</u>
It is not possible to switch the connectivity on/off with the connectivity switch.	There is an issue with the connectivity switch.	Contact customer support.	<u>1.4 Contact</u>
There are damages or scratches to the container base, walls, floor or other areas.	The container has been handled carelessly.	Contact customer support.	<u>1.4 Contact</u>

6. TECHNICAL SPECIFICATION

CODE	
IATA ULD type code	RLP
ATA code	LD-11
AS36100 identifier	2L5C
REFRIGERATION SYSTEM	
Air conditioning system with compressor cooling and electrical heating. Powered by rechargeable NiMH batteries.	
Power rating	100–240 V AC, 50–60 Hz, max 16 A
Recommended charging temperatures	+5 °C to +25 °C (+41 °F to +77 °F)
Charging temperature limits	-20 °C to +40 °C (-4 °F to +104 °F)
Typical charging time at recommended charging temperatures	11 hours
Cargo space temperature set point	Set point 5 and 20 °C (41 and 68 °F) Free set point 4-30 °C (39.2-86 °F)
Set point accuracy	±2 °C (±3.6 °F) for any set point
Autonomy at container temperature set point 5 °C	170 h at 20 °C (68 °F) ambient
Operational limits at any set point on battery power	-32 °C to +49 °C (-25.6 °F to +120.2 °F)
MONITORING CAPABILITIES	
Monitoring	8 Cargo space temperatures (°C) 2 Ambient temperatures (°C) Cargo space humidity (RH %) Ambient humidity (RH %) Cargo loaded inside (yes/no) Door openings (open/closed) Battery level (%) GPS location
DIMENSIONS	
External cube (volume)	7.9 m ³ (279 ft ³)
External dimensions (L x W x H)	3175 x 1534 x 1626 mm (125 x 60.39 x 64.02")
Internal dimensions (L x W x H)	2457 x 1354 x 1320 mm (96.73 x 53.31 x 51.97")
Door opening (W x H)	1354 x 1320 mm (53.31 x 51.97")
Internal cube (volume)	4.4 m ³ (156 ft ³)
Pallet capacity	3 EUR 1 pallets (800 x 1200 mm) (31.5 x 47.2") 2 US pallets (1016 x 1220 mm) (40 x 48")
WEIGHT	
Tare weight*	880 kg (1,940 lbs.)
Max gross weight	3175 kg (6,999 lbs.)
Max net weight*	2295 kg (5,060 lbs.)
OTHER INFORMATION	
Suitable for use on aircraft A300, A310, A330, A340, A350, A380, B747, B767, B777, B787, DC10, IL86, MD11, L1011. For other aircraft, alternative operating procedures may apply.	
Forkliftable with slot-height 93 mm (3.66"), slot-width 255 mm (10.04") and slot center to center distance 852 mm (33.54").	

*Tare weight and max net weight may change due to repairs, see the manufacturer's plate for correct weight.

6.1 DEFINITION OF DIMENSIONS

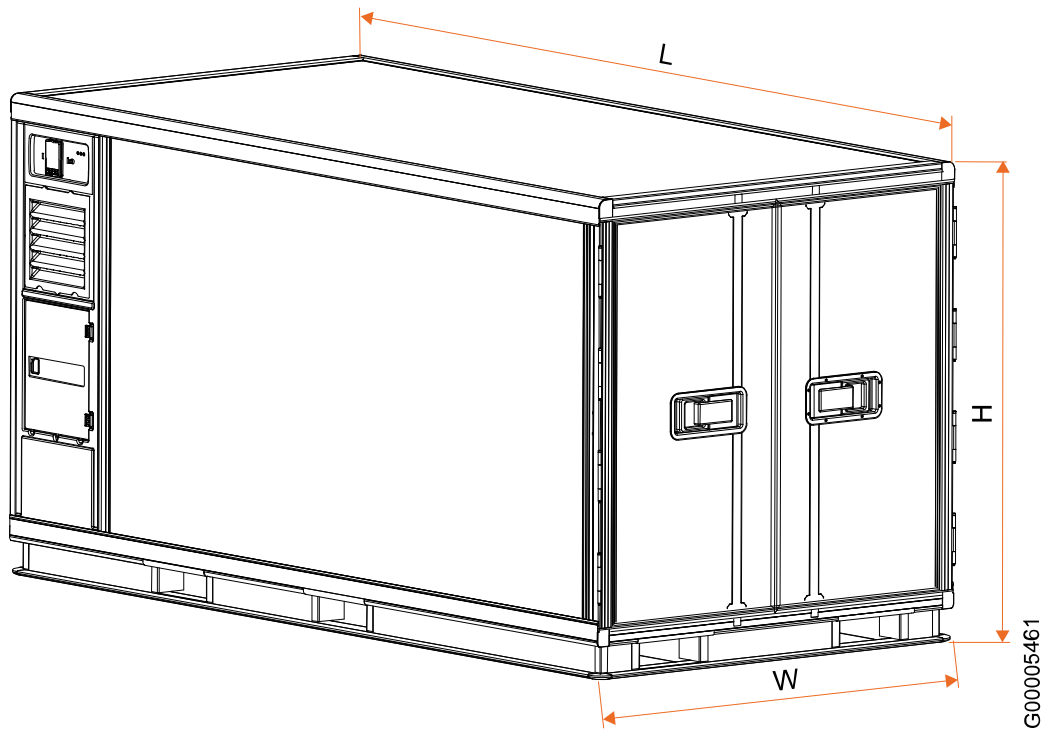

Fig. 40 Definition of dimensions

Intentionally left blank

Envirotainer Engineering AB

www.envirotainer.com

Doc No:

UM-RLP-1000

Revision:

9

State

Released

Release date:

2023-06-26

Approved by

hanst